

krafton[®]
VAN BIJL



ASSEMBLY INSTRUCTIONS
KRAFTON[®] GRP
BRIDGE DECKING PLANK 500.55

STEP 1: PREPARATION

1. General

These assembly instructions are intended for fitting the krafton GRP bridge decking planks on various subconstructions and are applicable for bicycle bridges, pedestrian bridges and platforms.

Special attention must be paid to the expansion of the bridge deck and the application of expansion joints where necessary. The material expands as a result of heating from the sun. For this reason, the installation of expansion joints must be taken into account in order to compensate for the expansion. Please follow the instructions in these assembly instructions.

Please read these assembly instructions carefully and keep them handy when installing the product. Follow the instructions for safe and correct installation of the bridge decking planks. The manufacturer accepts no liability for damage resulting from improper installation and use.

2. Required tools and fasteners

Cutting: The material is best cut with a diamond saw. For example, a hand-held circular saw with a diamond blade.

Grinding: A grinder can also be used. This grinder must be fitted with a diamond blade for grinding dry concrete.

Drilling: If you choose to drill, a metal drill will suffice in most cases.

Our scope of delivery includes all necessary fixing materials.

3. Symbols and Safety instructions

- Please ensure correct use and application of personal protective equipment.
- Wear a dust mask, grinding goggles and gloves.
- We also recommend the use of dust extractors when cutting and drilling, as well as hearing protection.



4. Substructure

- The substructure should be constructed taking into account the technical properties of the bridge decking planks used.
- The substructure must be level.
- We recommend that you provide sufficient gradient to prevent puddles of water from forming. Dirt collects in these puddles, which can freeze in winter conditions. This can cause slipperiness and risk of skidding.

krafton® is a registered trademark

THE SPECIALIST IN GLASS FIBRE-REINFORCED PLASTIC BRIDGE DECKING

krafton® 500.55 assembly instructions
August 2021

No part of this publication may be reproduced by means of printing, photocopying, computerised file system or in any other form without the prior written consent of the originator.

STEP 2: ASSEMBLY

1. Application of EPDM rubber protector

Apply the supplied EPDM rubber protector with a minimum thickness of 1.2 mm between the bridge decking planks and the substructure before installing the bridge decking planks.

- The rubber intermediate layer prevents the abrasion of sharp steel edges in the legs of the bridge decking planks.
- The rubber intermediate layer also reduces sound transmission.
- Finally, the rubber protects the substructure against moisture from above.

2. Expansion of the bridge decking planks

The use of different materials causes differences in expansion and corresponding length changes. This must be taken into consideration when fitting the bridge decking planks.

The following expansion rates apply at application temperatures of -20°C to +80°C:

- Longitudinal direction: approx. 1.0 mm per meter.
- Transverse direction: approx. 1.6 mm per meter.
- At intermediate temperatures, proportionally smaller expansions occur.

- The required expansion space depends on:
- The expansion of the substructure ;
- Temperature conditions (minimum and maximum temperature);
- Colour of the bridge decking planks; dark colours can reach a temperature of 80°C in direct sun.

At least 10 mm dilatation space between a group of 8 bridge decking planks must be maintained for correct fitting. The customer shall have final responsibility for the correct dilatation space.

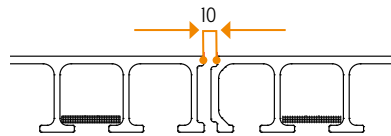

If an anti-skid surface is to be applied after installation, the dilatation joints must remain free from surface dusting agents and/or synthetic resin.

A good way to prevent this is to apply a strip of polyethylene (PE) in the dilatation joints, which only needs to be removed after the anti-slip layer has been applied. This way the dilatation joint remains clean and retains its function.

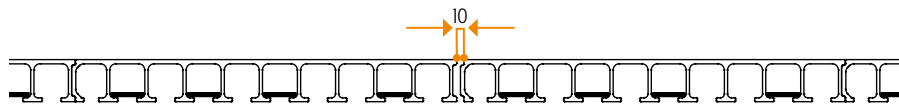

3. Spacer EPDM

The scope of delivery includes a spacer made of EPDM cellular rubber measuring 25x25x3 mm. It is recommended to glue a spacer every 500 mm between the bridge decking planks. This offers the benefit of guaranteeing the expansion of the bridge decking planks and drainage of water between the planks. In addition, the edges of the anti-skid surface are better protected against the reciprocal movement of the bridge decking planks, which prevents them from chipping. No spacer is used for the 1-3 mm wear layer. These planks can be fitted in the order shown on the plank.

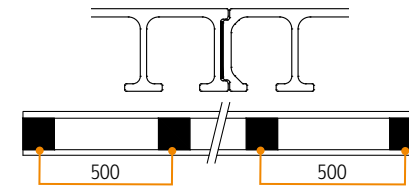

4. Fitting the first and last bridge decking planks and dilatation

The bridge decking planks must be extra secured at the first and last bridge

decking plank, as well as at the first and last bridge decking plank after an expansion joint. This fastening is achieved by an extra connection in the leg of the plank, as indicated in the various fitting methods. The extra mounts should be mounted at the location shown below.

5. Fitting methods

The following conditions must be observed when fitting the planks. Fastening must comply with the following specifications:

- Three fastenings per bridge decking plank and per beam.
- The beam width must be at least 60 mm for steel and 100 mm for wood.
- The minimum thickness of the steel flange is 6 mm.
- To protect the bridge decking plank, always place the supplied EPDM rubber protector with a minimum thickness of 1.2 mm between the bridge decking plank and the substructure.
- The screws must be set in the middle of the webs of the GRP plank.

The appendices contain a description of each fitting method.

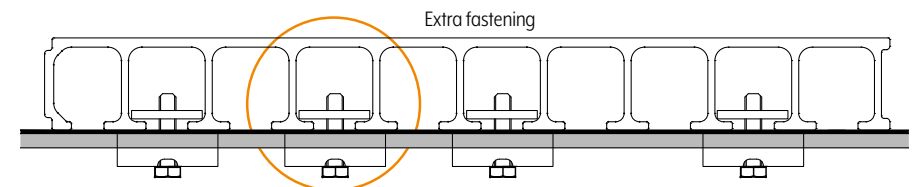

STEP 3: FINISHING AND AFTERCARE

1. Finishing with angle profile

The planks can be finished easily and attractively using the angle profile supplied. The angle profile is easy to install from above using the supplied round head screws.

2. Maintenance instructions

For long-term maintenance of the bridgedeck we recommend that you clean the bridge-deck annually using high-pressure cleaning. This will remove stones and dirt on the bridge deck and between the bridge decking planks from the expansion joints. If this dirt remains in the joints, it may result in damage to the bridge decking planks and the wear layer. After cleaning you can also check the bridge for any damage. Furthermore, we recommend that you check the fastenings annually and tighten them if necessary. This prevents noise nuisance caused by the deck rattling.

On steel, with beam clips and retainer plate

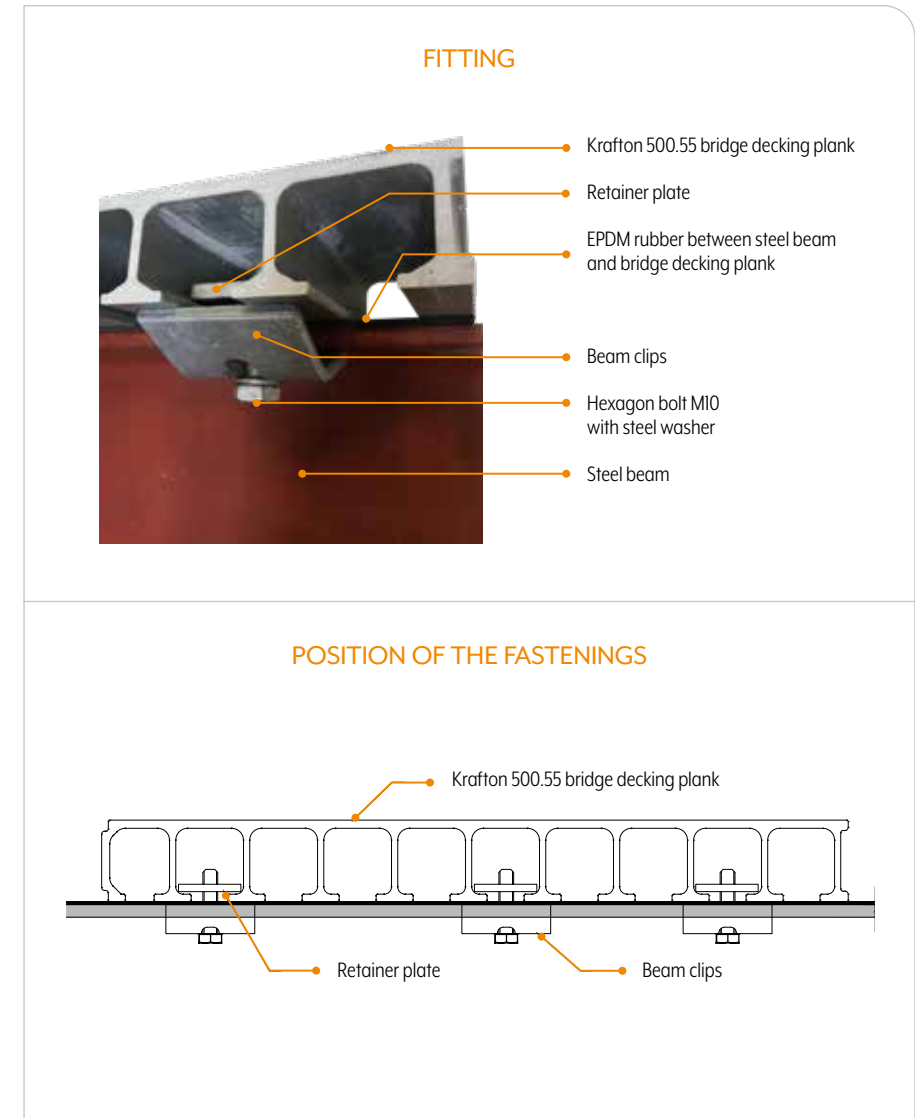

On timber, with steel angle profile and retainer plate

FITTING

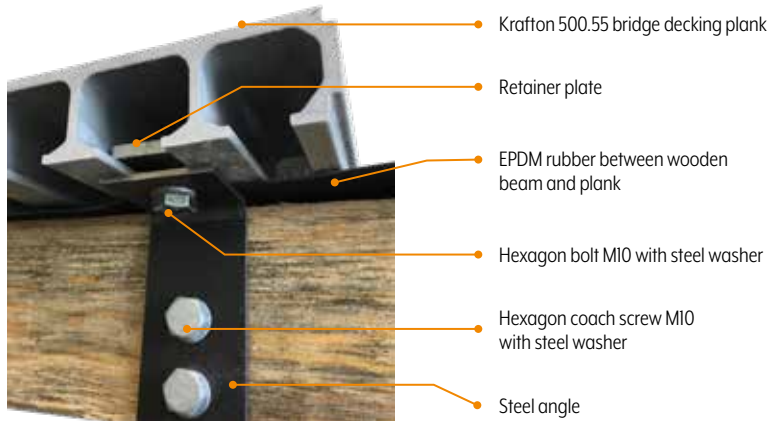

POSITION OF THE FASTENINGS

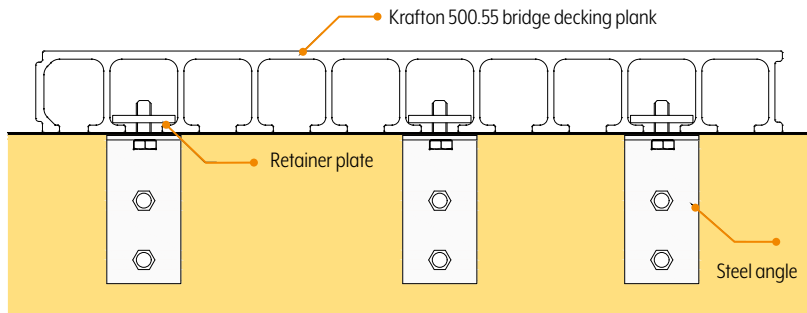

On timber, with continuous GRP angle profile, beam clips and retainer plate

FITTING

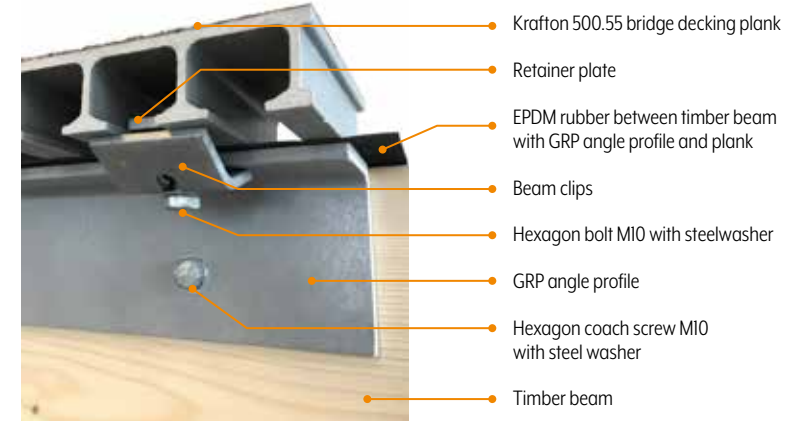

POSITION OF THE FASTENINGS

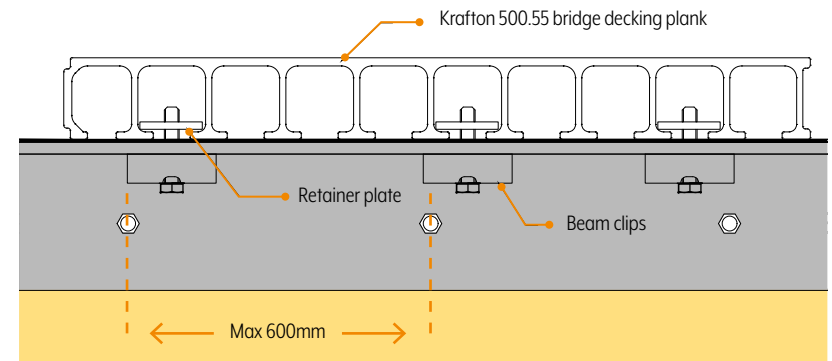

On steel or GRP, with retainer plate

FITTING

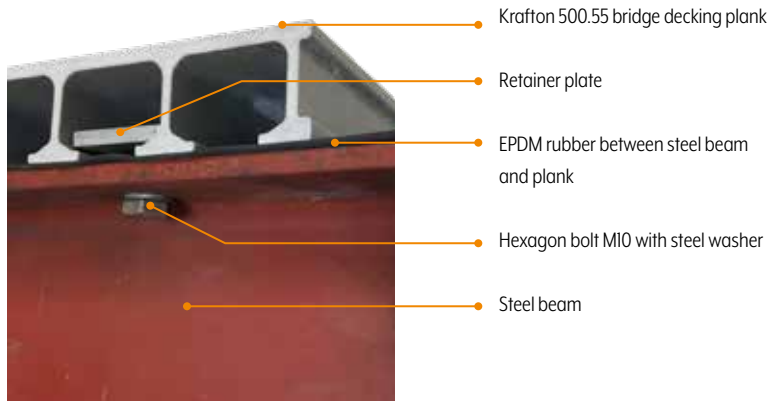

POSITION OF THE FASTENINGS

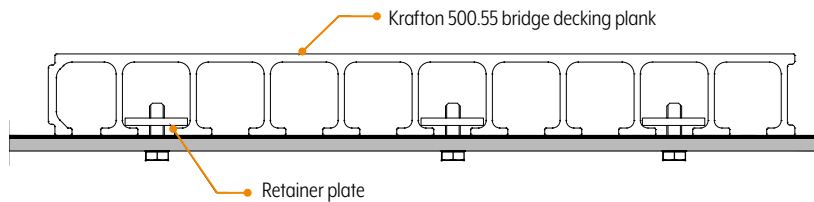

On timber, with GRP angle profile and retainer plate

FITTING

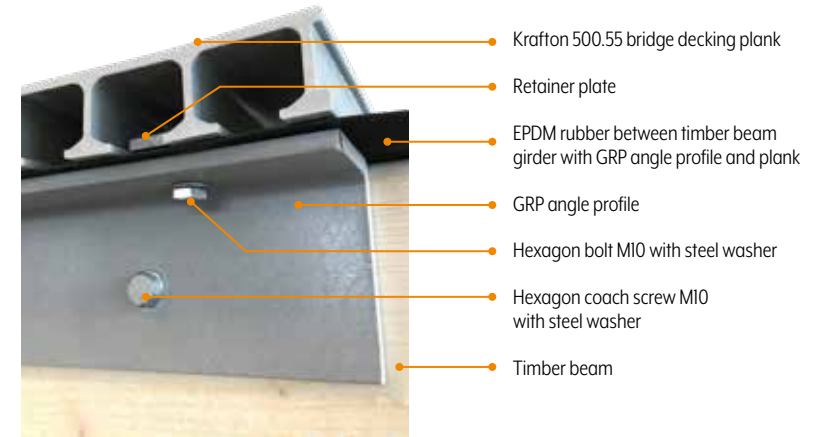

POSITION OF THE FASTENINGS

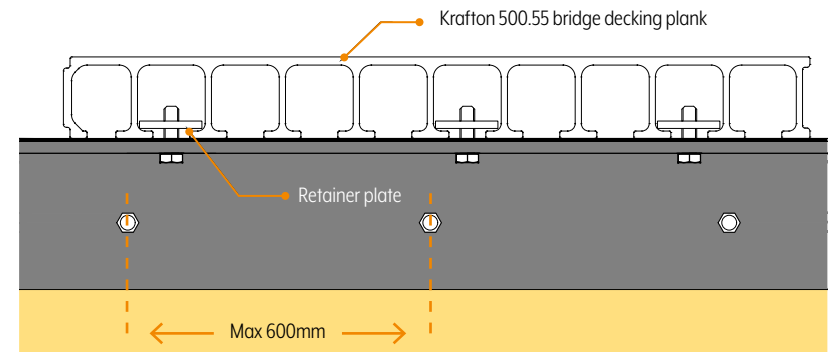

On steel or GRP, with PE retainer insert and beam clips

FITTING

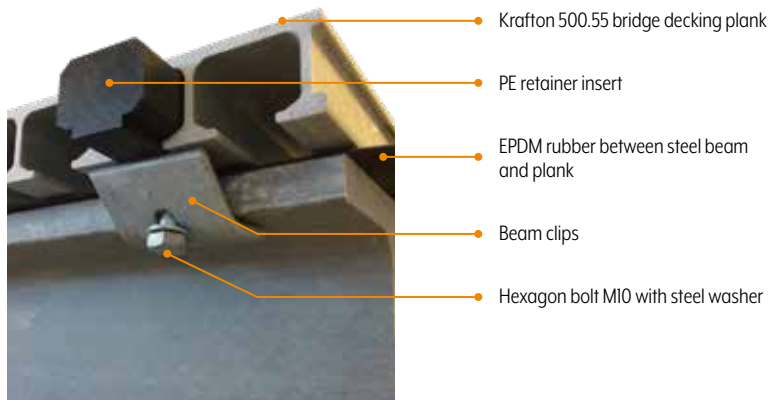

POSITION OF THE FASTENINGS

Tighten the screw with a torque of 30 Nm.
If the PE retainer insert is overtightened, a new PE retainer insert must be used.

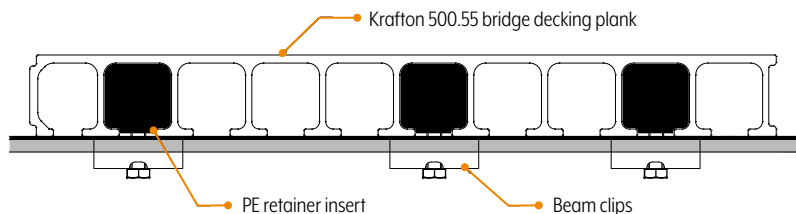

On timber, with steel angle profile and PE retainer insert

FITTING



POSITION OF THE FASTENINGS

Tighten the screw with a torque of 30 Nm.
If the PE retainer insert is overtightened, a new PE retainer insert must be used.

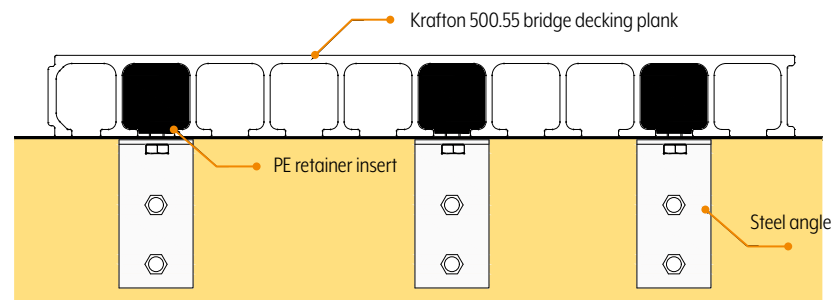

On timber, with PE retainer insert and pan-head screw

FITTING

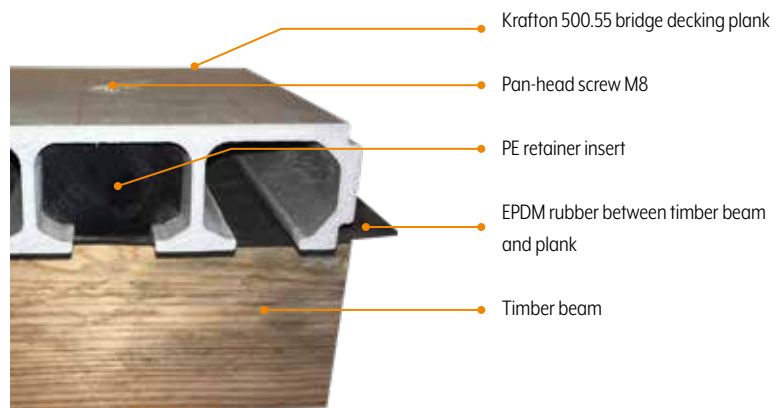

POSITION OF THE FASTENINGS

The pan-head screw M8 must be tightened with a torque of 15 Nm.

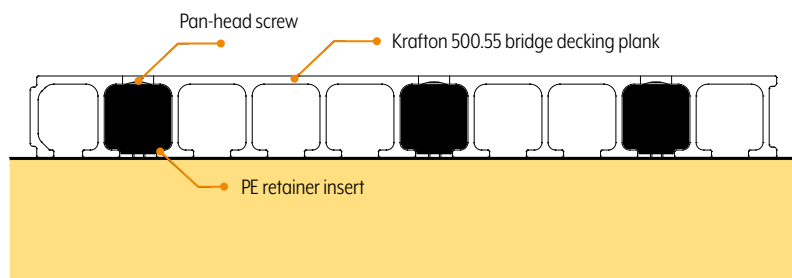

On steel or GRP, with PE retainer insert, pan-head screw and PE beam

FITTING

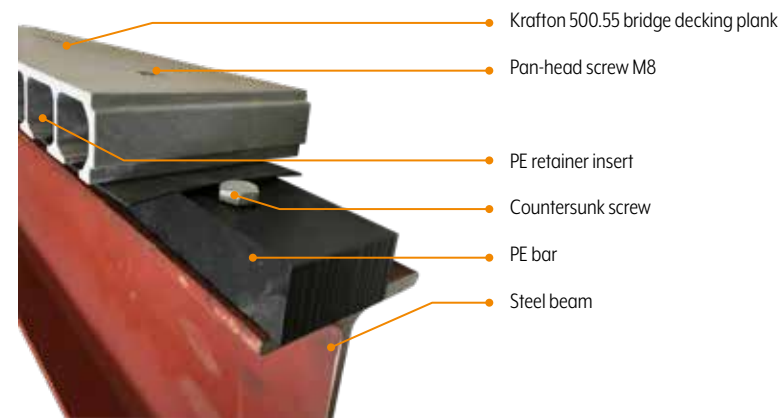

POSITION OF THE FASTENINGS

Tighten the screw with a torque of 30 Nm.

If the PE retainer insert is overtightened, a new PE retainer insert must be used.

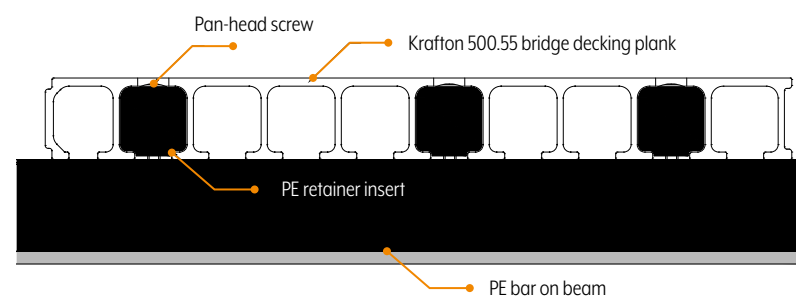

On steel, with PE retainer insert and coach screw beam clips

FITTING

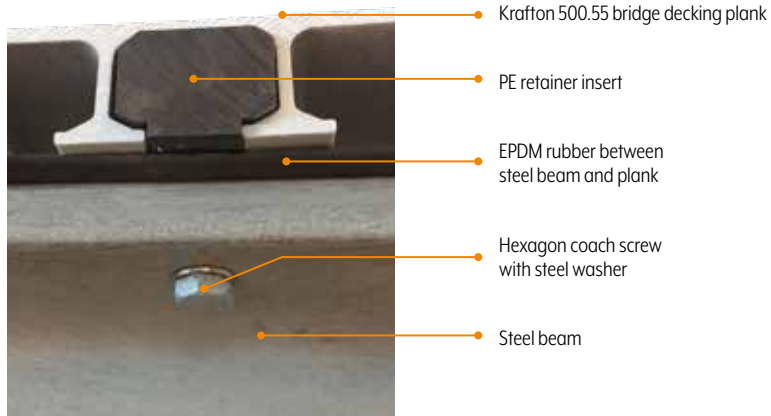

POSITION OF THE FASTENINGS

Tighten the screw with a torque of 30 Nm.
If the PE retainer insert is overtightened, a new PE retainer insert must be used.

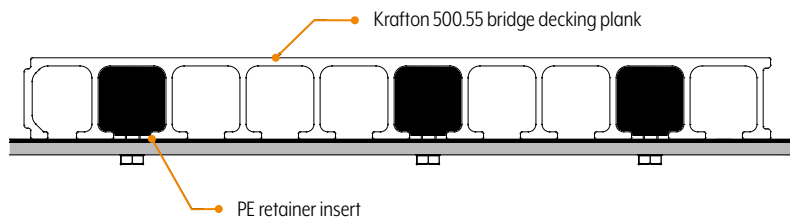

On timber, with PE retainer insert, GRP angle profile

FITTING

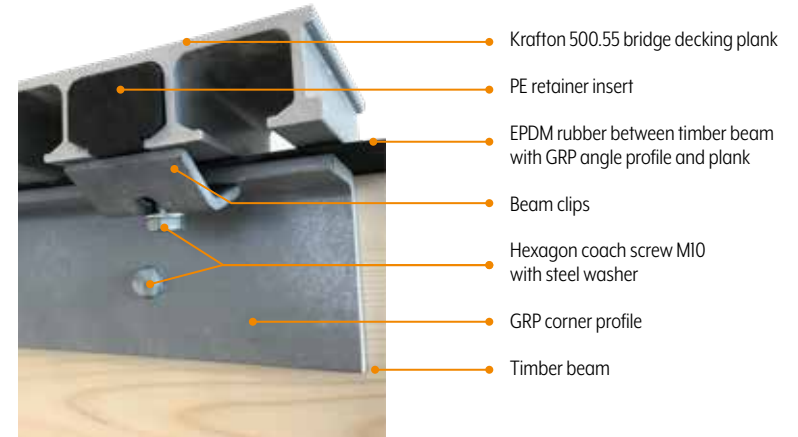

POSITION OF THE FASTENINGS

Tighten the screw with a torque of 30 Nm.
If the PE retainer insert is overtightened, a new PE retainer insert must be used.

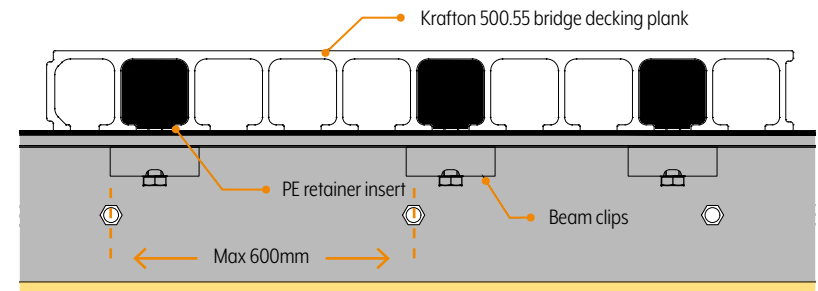

On timber, with PE retainer insert, continuous GRP angle profile and screw

FITTING

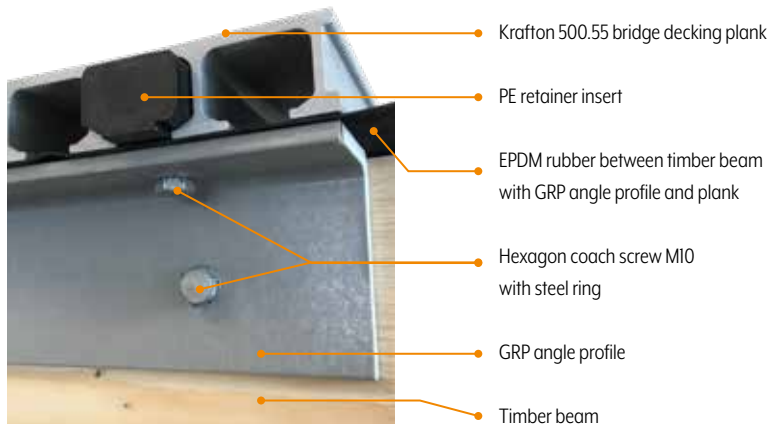

POSITION OF THE FASTENINGS

Tighten the screw with a torque of 30 Nm.
If the PE retainer insert is overtightened, a new PE retainer insert must be used.

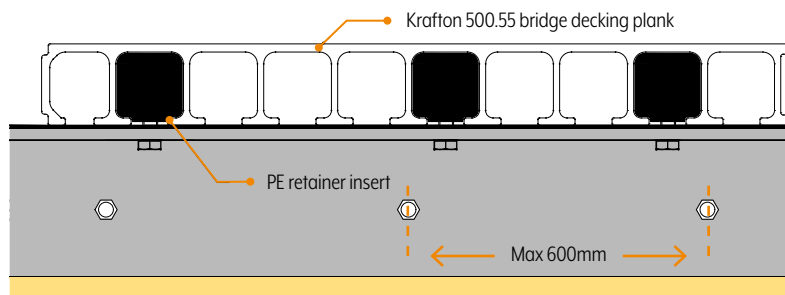

ABOUT US

kraffton® (Heijningen, founded in 1978) is the leading producer of fibre-reinforced polyester profiles and bridge decking planks. Every year we deliver significant quantities of standard profiles, customised profiles and bridge decking planks. Our products are used by customers throughout Europe: in infrastructure, construction, rail infrastructure, logistics, offshore, horticulture, sports and recreation.

kraffton® products are of excellent and consistent quality, which have been awarded many quality marks and certifications, including EBA, DIBt and TÜV.

kraffton®
VAN BIJL

kraffton®
Markweg Zuid 34, NL-4794 SN Heijningen, Nederland
T +31 (0)167 52 17 17, F +31 (0)167 52 18 18
info@kraffton.nl www.kraffton.nl